



Most Widely Accepted and Trusted

ICC-ES Report

ICC-ES | (800) 423-6587 | (562) 699-0543 | www.icc-es.org

ESR-1381

Reissued 11/2016
This report is subject to renewal 11/2017.

DIVISION: 07 00 00—THERMAL AND MOISTURE PROTECTION
SECTION: 07 44 00—FACED PANELS
SECTION: 07 46 00—SIDING

REPORT HOLDER:

MEXALIT INDUSTRIAL, S.A. DE C.V.

**SEGUNDO ANILLO PERIFERICO 6625
COLONIA EJIDO EL PROGRESO
NUEVO LAREDO, TAMAULIPAS, MEXICO**

EVALUATION SUBJECT:

**MEXALIT PRODUCTS FOR EXTERIOR SIDING, BACKER BOARD AND SOFFIT
APPLICATIONS: MAXIPANEL, MAXISOFFIT, MAXIPLANK, MAXIBACKER AND
MULTISHAKE**



Look for the trusted marks of Conformity!

“2014 Recipient of Prestigious Western States Seismic Policy Council (WSSPC) Award in Excellence”



A Subsidiary of  **INTERNATIONAL CODE COUNCIL**

ICC-ES Evaluation Reports are not to be construed as representing aesthetics or any other attributes not specifically addressed, nor are they to be construed as an endorsement of the subject of the report or a recommendation for its use. There is no warranty by ICC Evaluation Service, LLC, express or implied, as to any finding or other matter in this report, or as to any product covered by the report.



ICC-ES Evaluation Report

ESR-1381

Reissued November 2016

This report is subject to renewal November 2017.

www.icc-es.org | (800) 423-6587 | (562) 699-0543

A Subsidiary of the International Code Council®

DIVISION: 07 00 00—THERMAL AND MOISTURE PROTECTION

Section: 07 44 00—Faced Panels

Section: 07 46 00—Siding

REPORT HOLDER:

MEXALIT INDUSTRIAL, S.A. de C.V.
SEGUNDO ANILLO PERIFÉRICO 6625
COLONIA EJIDO EL PROGRESO 88123
NUEVO LAREDO, TAMAULIPAS
MEXICO
011-52-867-890-0250
www.maxitile.com
Shawn@maxitile.com

EVALUATION SUBJECT:

MEXALIT PRODUCTS FOR EXTERIOR SIDING, BACKER BOARD AND SOFFIT APPLICATIONS: MAXIPANEL, MAXISOFFIT, MAXIPLANK, MAXIBACKER AND MULTISHAKE

1.0 EVALUATION SCOPE

Compliance with the following codes:

- 2006 *International Building Code*® (IBC)
- 2006 *International Residential Code*® (IRC)
- Other Codes (see Section 8.0)

Properties evaluated:

- Durability
- Weather protection
- Wind resistance

2.0 USES

MaxiPanel, Maxisoffit, MaxiPlank and Multishake Sidewall panels are exterior wall sidings used as exterior wall coverings on buildings of all construction types over approved sheathings or framing, as applicable. The products are capable of resisting design loads, including wind, and are also used as closures on the underside of exterior roof eaves (Maxisoffits). MaxiBacker is used as nonstructural flooring underlayment and interior wall surface tile backer board, including in shower and bath areas (excluding the shower floor).

3.0 DESCRIPTION

MaxiPanel, MaxiSoffit, MaxiPlank, MaxiBacker and MultiShake Sidewall Panels are flat, fiber-cement sheet materials. The products are composed of cement, silica

sand and cellulose fibers, and are available with smooth or wood-grain exterior surfaces. The products are available either factory-primed or unprimed. The products are noncombustible in accordance with ASTM E 136.

MaxiPanel, MaxiSoffit and MaxiBacker are flat sheet panels. MaxiBacker has square or recessed edges. MaxiPlank and Multishake sidewall panels are lap siding boards. MultiShake Sidewall Panels are manufactured with straight or staggered edges and with wood texture.

Nominal dimensions of the products are shown in Table 1.

4.0 INSTALLATION

4.1 General:

Installation of the products must be in accordance with the manufacturer's published installation instructions and this report. The products can be cut with a power saw using a masonry carbide- or diamond-tipped blade, or with a hand guillotine or with a knife supplied by the manufacturer. The framing assembly components must be sized and constructed to meet applicable building code requirements. Wood and steel framing must be spaced as identified for the applicable assembly in Table 2. Steel framing must be minimum No. 20 gage [0.035 inch (0.89 mm)]. Fasteners and steel framing must be corrosion-resistant. In accordance with the manufacturer's instructions, the siding products must be coated with an exterior-grade, 100 percent acrylic or latex wall coating. Primers, if used, must be a 100 percent acrylic or latex primers. A water-resistive barrier complying with IBC Section 1404.2 or IRC Section R703.2 must be installed under the wall siding products.

Installation under the IBC and the IRC must comply with IBC Sections 1405.15 and 1405.17 and IRC Sections R703.10 and Table R703.4 for fiber cement siding, and be as noted in Sections 4.2, 4.3 and 4.4.

4.2 Siding:

4.2.1 MaxiPanel and MaxiSoffit: MaxiPanel and MaxiSoffit must be installed on wood or steel framing in accordance with IBC Section 1405.17 and IRC Section R703.10.1. Fasteners are described in Table 2. Fasteners must be placed a minimum of 2 inches (51 mm) from corners and $\frac{3}{8}$ inch (9.5 mm) from edges. See Figures 1, 2 and 3 for details.

Panel joints must occur over framing. A maximum gap of $\frac{1}{16}$ inch (1.6 mm) is permitted between panels, and the gap must be caulked with an approved exterior latex caulk. See Figures 4 and 5 for jointing methods. Flashing must be installed at all corners and openings.

4.2.2 MaxiPlank: MaxiPlank must be installed on wood or steel framing in accordance with IBC Section 1405.17 and IRC Section R703.10.2. Fasteners used at each stud are described in Table 2. For exposed fastening, fasteners must be placed a minimum of $\frac{3}{4}$ inch (19.1 mm) up from the bottom edge of the plank, except when butt-jointing over studs, in which case the fasteners must be placed a minimum of 1 inch (25.4 mm) up from the bottom edge. Fasteners must be placed a minimum of $\frac{3}{8}$ inch (9.5 mm) from plank ends. See Figures 6, 7 and 8 for details.

For concealed fastening, fasteners must be placed a minimum of 1 inch (25.4 mm) down from the top edge of the plank, and a minimum of $\frac{3}{8}$ inch (9.5 mm) from plank ends. See Figures 9 and 10 for details.

Adjacent planks may be butt-jointed together over studs or be centered over a No. 26 gage galvanized steel joint plate. Caulking at butt-joints must completely fill the void. See Figures 11, 12 and 13 for details. Joints must be staggered a minimum of 2 feet (610 mm) from adjacent courses. Plank overlap may be varied to suit the particular height of the wall; the minimum overlap is $1\frac{1}{4}$ inches (31.7 mm). Stops and flashing must be installed at all corners and openings.

4.2.3 MultiShake: MultiShake Sidewall Panels must be installed over wood-based structural sheathing and wood framing in accordance with IBC Section 1405.17 and IRC Section R703.10.2. The siding products must be installed only on exterior walls covered by solid sheathing attached as required by the applicable code and capable of independently supporting the imposed loads, including but not limited to transverse wind loads. Fasteners used to attach the MultiShake panels must be attached as described in Table 2. Metal or wood stops must be installed at all corners. Details of installations are shown in Figures 15 and 16.

Straight-edge MultiShake panels must be installed with a 9-inch (229 mm) overlap and a maximum 7-inch-wide (178 mm) exposure; staggered-edge MultiShake panels must be installed with a 10-inch (254 mm) overlap and a maximum 6-inch-wide (152 mm) exposure. Straight-edge and staggered-edge MultiShake panels are shown in Figure 17.

4.3 MaxiBacker:

In flooring applications, MaxiBacker is installed as an underlayment over a minimum $\frac{3}{4}$ -inch (19.1 mm), exterior-grade plywood subfloor complying with, and installed in accordance with, the applicable code. The plywood subfloor system must be designed so that maximum deflection in a plane, including live and dead loads, is $\frac{1}{240}$ of the span or, for live loads, $\frac{1}{360}$ of the span, in accordance with the applicable code. MaxiBacker must be fastened to the plywood subfloor with No. 11 gage by $1\frac{1}{4}$ -inch-long (32 mm), galvanized roofing nails or No. 8 by $1\frac{1}{4}$ -inch-long (32 mm) C-Drill screws. Nails or screws are spaced at 6 inches (152 mm) on center around the perimeter and in the field, a minimum of $\frac{3}{8}$ inch (9.5 mm) from edges and 2 inches (51 mm) from corners. A $\frac{1}{8}$ -inch (3.2 mm) gap must be left between board and walls to allow for expansion. Subsequent finishing with flooring, tile or other finished flooring is required. For applications to the interior face of walls, MaxiBacker must be installed as described in Section 4.2 of this report.

4.4 Wind Resistance:

The design wind speeds must not exceed the maximum basic wind speed shown in Table 2 of this report. Resistance to wind loads is also determined by the structural capacity of the substrate.

5.0 CONDITIONS OF USE

The MaxiPanel exterior siding products described in this report comply with, or are suitable alternatives to what is specified in, those codes listed in Section 1.0 of this report, subject to the following conditions:

- 5.1 The products must be manufactured, identified and installed in accordance with this report, the manufacturer's published installation instructions and the applicable code. In the event of conflict between the manufacturer's published installation instructions and this report, this report governs.
- 5.2 A water-resistive barrier complying with the IBC or the IRC, as applicable, must be installed under the exterior wall siding products.
- 5.3 The exterior siding and soffit products have not been evaluated for racking resistance. Walls must be braced by other means as required by the applicable code.
- 5.4 The Multishake siding products must be installed only on exterior walls covered by solid sheathing capable of independently supporting the imposed loads, including, but not limited to, transverse wind loads.
- 5.5 The products are manufactured by Mexalit Industrial, S.A. de C.V., in Santa Clara, Estado de Mexico, Mexico; Nuevo Laredo, Estado de Tamaulipas, Mexico; and Guadalajara, Jalisco, Mexico, under a quality control program with inspections by ICC-ES.

6.0 EVIDENCE SUBMITTED

- 6.1 Data in accordance with ICC-ES Acceptance Criteria for Fiber Cement Siding Used as Exterior Wall Siding (AC90), dated October 2005 (editorially revised January 2008).
- 6.2 Data in accordance with ICC-ES Acceptance Criteria for Fiber-cement Interior Substrate Sheets Used in Wet and Dry Areas (AC378), dated October 2007.

7.0 IDENTIFICATION

7.1 MaxiPanel, MaxiSoffit, MaxiBacker and MultiShake:

Each panel is marked with the product name, thickness and lot number. Each pallet of panels bears a label indicating the name and address of Mexalit Industrial, S.A. de C.V.; the product designation; and the evaluation report number (ESR-1381).

7.2 MaxiPlank:

One plank in each pallet tier is marked with the product name and lot number. Each pallet bears a label with the name and address of Mexalit Industrial, S.A. de C.V.; the product designation; and the evaluation report number (ESR-1381).

8.0 OTHER CODES

8.1 Scope:

In addition to the codes referenced in Section 1.0, the products in this report were evaluated for compliance with the 1997 *Uniform Building Code*™ (UBC)

8.2 Uses:

See Section 2.0.

8.3 Description:

See Section 3.0.

8.3 Description:

See Section 3.0.

8.4 Installation:

8.4.1 General: See Section 4.1, except a weather-resistive barrier complying with Section 1402.1 of the UBC must be installed under the MaxiPanel exterior wall siding products.

8.4.2 Siding:

8.4.2.1 MaxiPanel and MaxiSoffit: See Section 4.2.1.

8.4.2.2 MaxiPlank: See Section 4.2.2.

8.4.2.3 MultiShake: See Section 4.2.3.

8.4.3 MaxiBacker: See Section 4.3.

8.4.4 Wind Resistance: The design wind speeds must not exceed the maximum basic wind speeds shown in Table 2 of this report. Resistance to wind loads is also determined by the structural capacity of the substrate.

8.5 Conditions of Use:

8.5.1 See Section 5.1.

8.5.2 A weather-resistive barrier complying with the UBC as applicable, must be installed under the MaxiPanel exterior wall siding products.

8.5.3 See Section 5.3.

8.5.4 See Section 5.4.

8.5.5 See Section 5.6.

8.6 Evidence Submitted:

See Section 6.0.

8.7 Identification:

See Section 7.0.

TABLE 1—DIMENSIONS OF MAXIPANEL, MAXIPLANK AND MULTISHAKE PRODUCTS

PRODUCT	WIDTH (inches)	LENGTH (feet)	THICKNESS (inch)
MaxiPanel	48	8, 9, 10, 12	⁵ / ₁₆ , ⁷ / ₁₆
MaxiSoffit	12, 16, 24, 48	8,10, 12	¹ / ₄
MaxiPlank	5 ¹ / ₄ , 6 ¹ / ₄ , 7 ¹ / ₄ , 8 ¹ / ₄ , 9 ¹ / ₄ , 12	12	⁵ / ₁₆
MaxiBacker	36, 48	4, 5, 8, 9, 10	¹ / ₄ , ¹ / ₂ , ⁵ / ₁₆
MultiShake	16	4	¹ / ₄

For SI: 1 inch = 25.4 mm, 1 foot = 304.8 mm.

TABLE 2—MAXIMUM WIND LOADS

PRODUCT	THICKNESS (inch)	FASTENER TYPE	FASTENER SPACING	FRAME TYPES	STUD SPACING (inches)	HEIGHT OF BUILDING (feet)	MAXIMUM BASIC WIND SPEED (mph) FOR EXPOSURE CATEGORY ⁷					
							IBC, IRC9			UBC8		
							B	C	D	B	C	D
MaxiPanel	5/16	6d common 2-inch-long nails ²	6 inches on center	2-by-4 wood ⁵	16	15	140	130	120	120	110	100
						20	140	130	120	120	110	100
						40	140	130	115	120	110	95
						60	140	120	110	120	100	90
						100	130	110	-	110	90	-
200	120	105	-	100	85	-						
MaxiPanel	5/16, 7/16	No. 8 by 1 1/4-inch-long RPI C-Drill screws	6 inches on center	No. 20 gage by 3 7/8-inch by 1 3/8-inch metal C-Stud	16, 24	15	140	120	105	120	100	85
						20	110	110	100	120	90	80
						40	110	110	100	110	90	80
						60	100	100	90	100	80	75
						100	100	100	-	95	80	-
200	90	90	-	85	75	-						
MaxiPlank, maximum 12 inches wide	5/16	No. 11 gage, 2.087-inch-long, galvanized roofing nails ³	Through overlap every stud (exposed)	2-by-4 wood ⁵	16	15	125	100	85	105	80	70
						20	120	100	85	100	80	70
						40	110	90	-	90	75	-
						60	105	85	-	85	70	-
						100	-	-	-	-	-	-
MaxiPlank, maximum 9 1/2 inches wide	5/16	No. 11 gage, 1 3/4-inch-long, galvanized roofing nails ⁴	Through top edge of plank every stud (concealed)	2-by-4 wood ⁵	16	15	130	100	85	110	80	70
						20	120	100	85	100	80	70
						40	115	90	-	95	75	-
						60	110	85	-	90	70	-
						100	100	-	-	80	-	-
200	85	-	-	70	-	-						
MaxiPlank, maximum 9 1/2 inches wide	5/16	No. 8 by 1 5/8-inch-long RPI C-drill screws	Through overlap every stud (exposed)	No. 20 gage by 3 7/8-inch by 1 3/8-inch metal C-stud	16, 24	15	140	120	105	120	100	85
						20	140	120	100	120	100	80
						40	140	110	100	120	90	80
						60	130	105	90	110	85	75
						100	120	100	85	100	80	70
200	110	90	85	90	75	70						
MaxiPlank, maximum 9 1/2 inches wide	5/16	No. 8 by 1 1/4-inch-long RPI C-wing screws	Through top edge of plank every stud (concealed)	No. 20 gage by 3 5/8-inch by 1 3/8-inch metal C-stud	16, 24	15	120	90	-	100	75	-
						20	110	85	-	90	70	-
						40	105	-	-	85	-	-
						60	100	-	-	80	-	-
						100	85	-	-	70	-	-
MaxiSoffit	1/4	4d box 1 1/2-inch-long nails ¹	6 inches on center	2-by-4 wood ⁵	16	15	125	100	85	105	80	70
						20	120	100	85	100	80	70
						40	110	85	-	90	70	-
						60	105	85	-	85	70	-
MultiShake	1/4	0.113-inch x 2-inch-long x 0.267-inch (head diameter)	3 nails at each stud spaced 1/2 inch from each edge and at the center of the panel	2-by-4 wood ⁶	16	15	110	85	-	90	70	-
						20	105	-	-	85	-	-
						40	90	-	-	75	-	-
						60	85	-	-	70	-	-

For SI: 1 inch = 25.4 mm, 1 foot = 304.8 mm, 1 mph = 1.609 km/h.

¹Nail has 0.09-inch-diameter shank and 0.218-inch-diameter head.

²Nail has 0.125-inch-diameter shank and 0.265-inch-diameter head.

³No. 11 gage nail has 0.125-inch-diameter shank and 0.275-inch-diameter head.

⁴No. 11 gage galvanized roofing nail has 0.120-inch-diameter shank and 0.385-inch-diameter head.

⁵Wood specific gravity is 0.42 or higher.

⁶Wood specific gravity is 0.49 or higher.

⁷N/A—not applicable.

⁸Basic wind speed is the fastest mile speed in accordance with UBC Section 1616.

⁹Basic wind speed is the 3-second gust, miles per hour (km/hr), in accordance with IBC Section 1609.3 and IRC Section R301.2.

MAXIPANEL

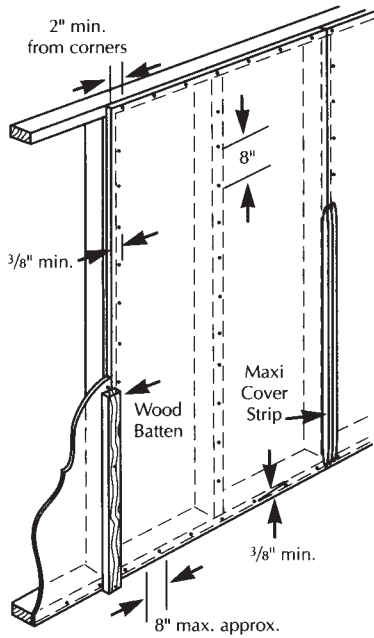

Fig. 1

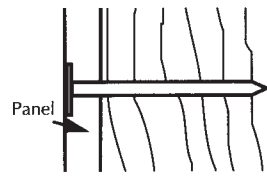

Fig. 2 Wood Stud

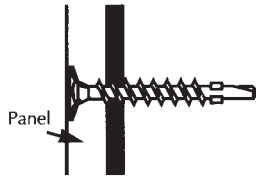

Fig. 3 Metal Stud

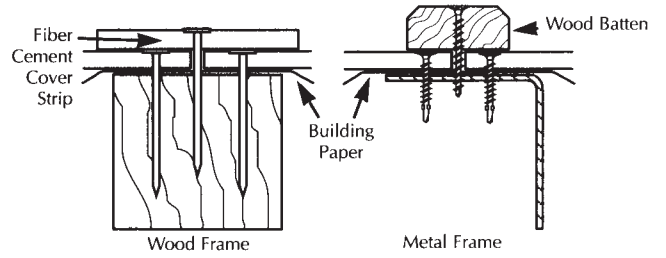

Fig. 4 Vertical Joints

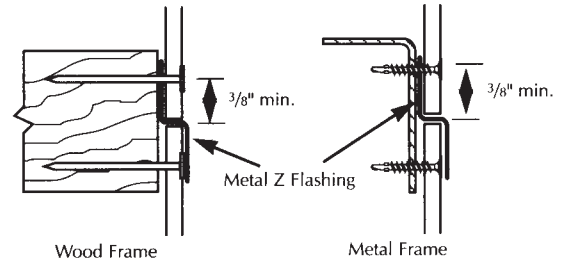

Fig. 5 Horizontal Joints

MAXIPLANK

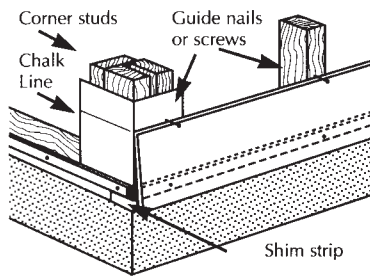

Fig. 6

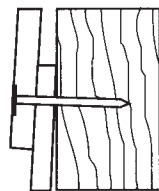

Fig. 7 Wood Stud

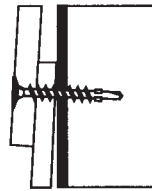

Fig. 8 Metal Stud

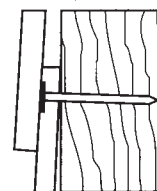

Fig. 9 Wood Stud

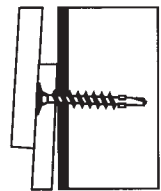

Fig. 10 Metal Stud

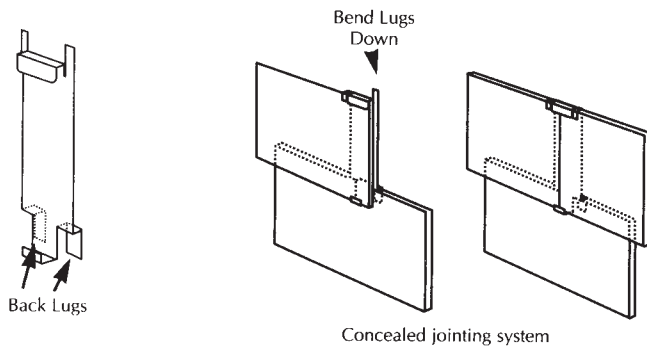

Fig. 11 Metal Joint Plate

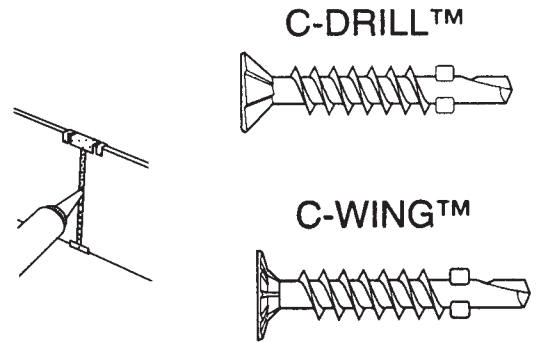

Fig. 12 Caulking of Plank Joint

Fig. 14

MULTISHAKE Sidewall Panels

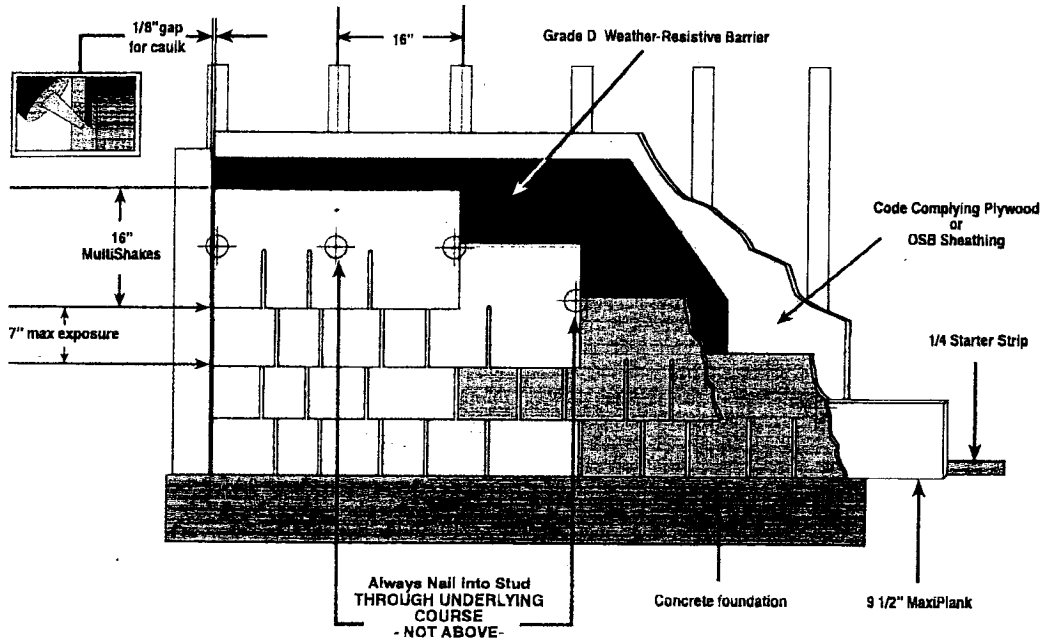

FIGURE 15

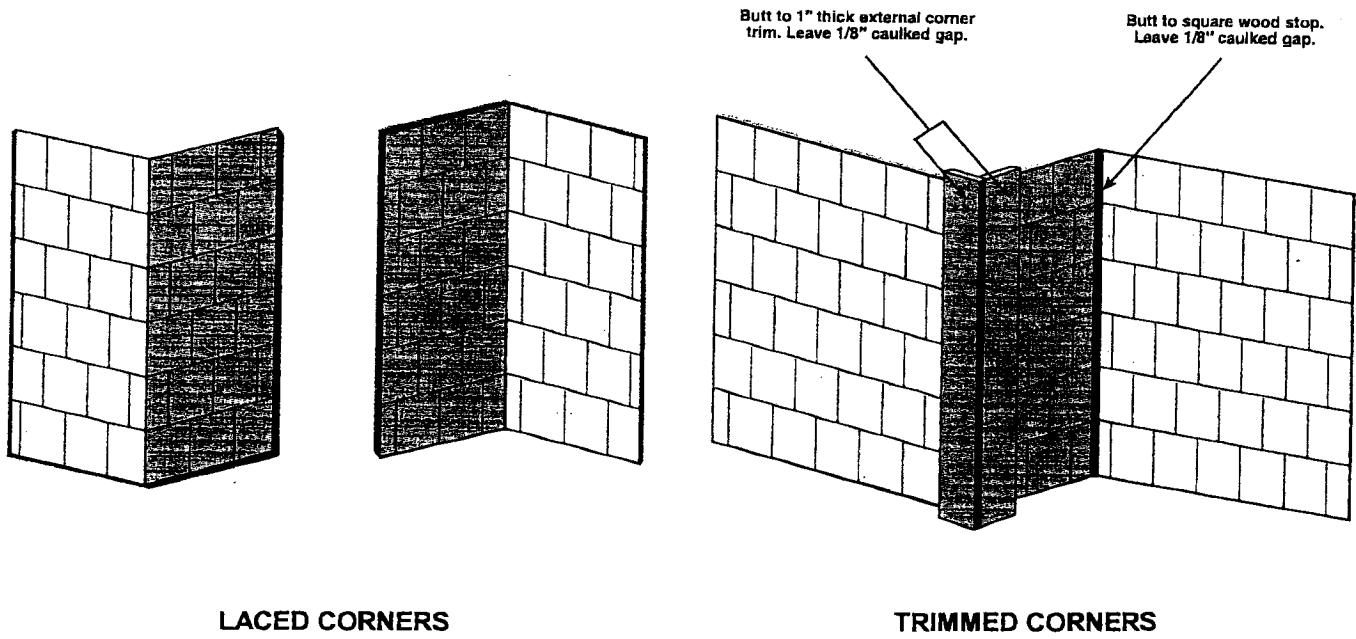
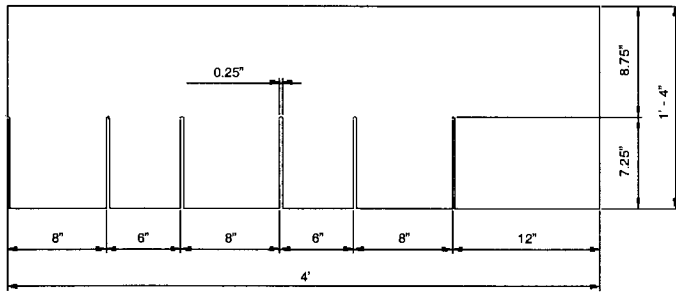

FIGURE 16

Straight Edge Panel
43 pieces per square - 7" exposure



Staggered Edge Panel
50 pieces per square - 6" exposure

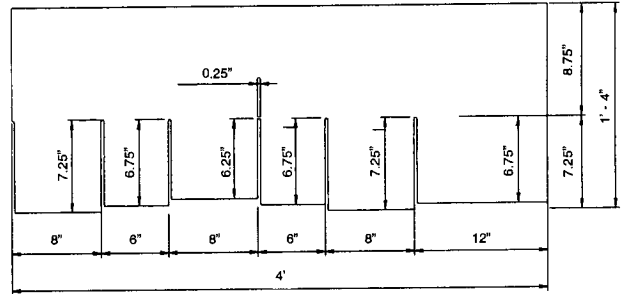

FIGURE 17